



[pro]master®

# Traveler + Battery Charger

**PLEASE READ AND FOLLOW ALL INSTRUCTIONS BEFORE USING THIS PRODUCT.**

## **IMPORTANT WARNING:**

The PROMASTER Traveler + Charger may **ONLY** be used for charging **rechargeable Li-Ion batteries!** Inserting any other battery type may damage the device, destroy the battery and/or cause serious injury to the user.

## **CAUTION:**

- Always unplug the charger when not in use.
- Always unplug your charger from the power source before cleaning.
- Always replace frayed or damaged wire and broken plugs immediately.
- Do not use, place or store the charger where it may come into contact with water or moisture.
- Do not short-circuit the metal contacts of the battery and charger.
- Do not disassemble, deform or reconstruct any part of the charger.

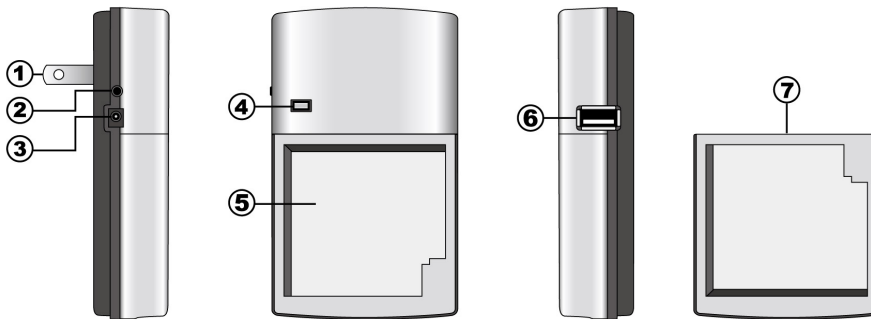

① AC Prongs

② Booster Switch

③ DC IN Socket

④ LED Charge Indicator

Red LED : Quick Charge

Green LED : Fully Charged/Standby

⑤ Battery Charging Port

⑥ 5V USB Power Port

⑦ Additional Battery Mounting Plate (Included with some models)

## **OPERATING INSTRUCTIONS:**

### **Charger Function :**

1. Rotate the AC prongs ① of Traveler + charger until they are fully extended and locked into position. Plug the charger directly into a household AC outlet or connect the barrel plug end from the DC Power Cord (included in the OPTIONAL Travel Accessory Kit which is sold separately) into the DC IN socket ③ on the left side of the charger unit and the other into the cigarette lighter receptacle of a vehicle with 12V or 24V battery. The LED ④ on the charger will turn GREEN to indicate the charger is properly powered and ready for use.
2. This PROMASTER® Traveler + charger has a multi-mount design and is compatible with more than one battery. Please refer to the "Battery Compatibility Illustration Chart" included in this package to find the appropriate contacts on this charger for your battery.
3. Mount the camera/camcorder battery you wish to charge onto the Traveler + charger following the illustration on the Compatibility chart. Make sure the battery is installed correctly by matching the contact pins and polarity symbols embossed on the charger. The LED ④ will turn RED to indicate the battery has been mounted correctly and the charger has begun to quick charge your camera/camcorder battery.

- Some Traveler + charger kits may come with an additional interchangeable battery mounting plate or plates ⑦. If you need to use an additional mounting plate, please remove the mounting plate installed on the charger base unit and replace it with the additional one by following the steps as shown in the diagrams below.

◆ To Remove the Battery Mounting Plate installed on the Traveler + Charger Base Unit.

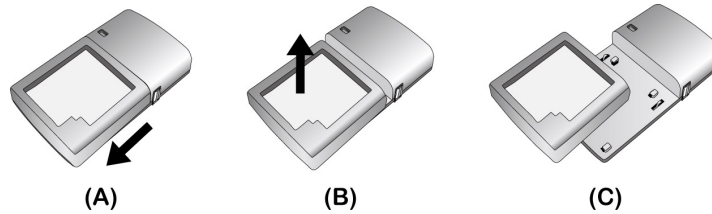

- Slide the battery mounting plate out by following the direction the arrow symbol indicates.
- Pull up the battery mounting plate.
- The battery mounting is now disconnected from the charger base unit.

◆ Install the Battery Mounting Plate onto the Traveler + Charger Base Unit.

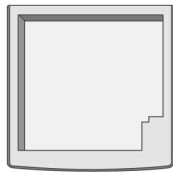

**Battery Mounting Plate**

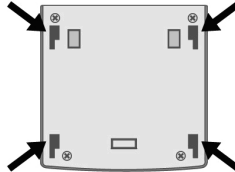

**Bottom View of Battery Mounting Plate**

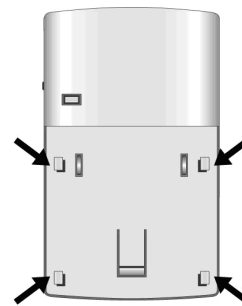

**Charger Base Unit**

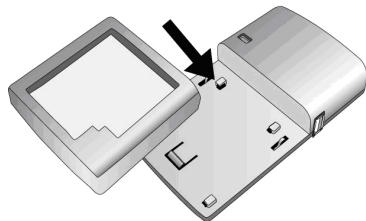

**Align & Press Down**

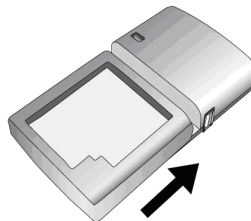

**Slide In**



**OK**

- Align the 4 holes at the bottom of the battery mounting plate with the 4 ribs on the charger base unit.
- Slide the battery mounting plate onto the charger base unit according to the direction the arrow symbol indicates in the above diagram until it locks into position.

- It may be necessary to turn the charger upside down to prevent the battery from falling off the charger when it is plugged into a WALL AC socket.
- Due to the protection circuitry built into a Li-Ion battery, some Li-Ion batteries that have not been used for an extended period of time may have very low or zero voltage and be detected as a defective battery. To re-activate a battery in this condition and charge it properly, it is necessary to use the boost function of this charger by pressing the "Booster Switch" ⑧ located at the left side of this charger (next to the DC IN socket) for at least 3 seconds prior to charging the battery. **Note:** The boost procedure is required only for and limited to a 7.2V/7.4V Li-ion battery and is not necessary for charging a 3.6V/3.7V Li-Ion battery under any circumstance.
- When the battery is charged to approximately 90% of its rated capacity, the LED ④ on the Traveler + charger will turn GREEN. The charger is now in the "TRICKLE CHARGE" mode. Once the LED has turned GREEN, you may remove your battery from the charger and use it immediately. To charge the battery to 100% of its capacity, it is recommended that you leave the battery on the charger for an additional 30 minutes (approximately) after the LED turns GREEN.
- Due to the advanced charge technology and smart circuitry, it is safe to leave your battery on the PROMASTER® Traveler + charger after it is fully charged. HOWEVER, to avoid the unnecessary power consumption and prolong the operating life of the charger, we do not recommend leaving the battery in the charger for extended periods of time.

## Power Supply Function:

The built-in 5V USB Port ⑥ enables the PROMASTER® Traveler + charger to work as a 5V USB Power Supply capable of powering and charging many portable electronic devices -- such as MP3/MP4 Player, Mobile Phone, etc.

### To Work as a 5V USB Power Supply

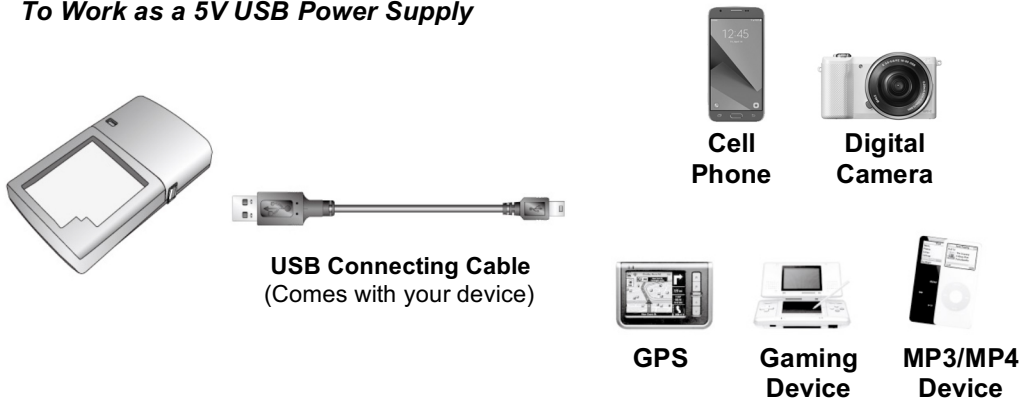

Note: The 5V USB Power Port of the Traveler + charger works only AFTER the battery being charged at the battery port is fully charged (its LED turns green) or when there is no battery being charged at the battery port of this charger. It is not possible to charge a battery and use USB power simultaneously.

### IMPORTANT NOTES:

1. All batteries will naturally discharge themselves even if they are not in use. To prolong their service life, it is recommended that you do not let a battery sit idle for more than two months without recharging. Also, due to the self-discharge, be sure to recharge your batteries before you plan to use them.
2. The batteries and the charger will get warm during the charging cycle. This is normal.
3. Keep the battery terminals clean.
4. Always insert the battery in the charger with the correct polarity (+ and – symbols in proper orientation).
5. If the charger does not charge the batteries, check to see if the battery is dead, faulty or worn out. All rechargeable batteries will eventually wear out after being used for a certain number of cycles.
6. Always keep metal contacts on both charger and battery clean by wiping the surfaces with a dry, soft and clean cloth.
7. Remove your batteries from the digital camera or camcorder after use. These devices will continue to drain a small current from your batteries even if they are turned off.

### TROUBLESHOOTING:

#### If the RED (charge) LED indicator does NOT light when the charger is plugged into a power source and the batteries have been inserted:

- The battery may not be properly inserted. Unplug the charger from power source and check to make certain the batteries are seated properly.
- Check and make sure metal contacts on both charger and battery are clean.

#### If the battery takes a much shorter time to reach full charge:

- There may still be some power left in the battery prior to being charged.
- The battery is getting old and should be replaced (an older battery may not accept much of a charge).

#### If the battery is providing a much shorter operating time after being fully charged:

- The battery may have sat idle without being charged for too long.
- The battery is worn out and about to reach the end of its service life. All rechargeable batteries will eventually wear out after being used for a certain number of cycles.

### SPECIFICATIONS:

Input Power :	100~240V AC, 50/60Hz 12~24VDC (for DC IN Socket)
Output Power :	4.2V/8.4V DC, Max. 750mA (with Auto Detection) 5.0V DC, Max. 650mA (for USB Power Port)

## **PROMASTER® One Year LIMITED WARRANTY:**

- 1) To claim warranty service, return your product to your Authorized PROMASTER Dealer along with a copy of the original sales receipt from an Authorized PROMASTER dealer bearing the purchaser's name, date of purchase and description of the item being submitted for warranty service. If it is not practical to return it to your Authorized PROMASTER dealer, your product may be returned PREPAID to the PROMASTER WARRANTY CENTER listed below.
- 2) If, in the sole opinion of PROMASTER, this product has become non-functional due to a defect in the workmanship or materials at the original point of manufacturing, PROMASTER will repair or replace (at PROMASTER's option) this product without charge. In the event of replacement, PROMASTER reserves the right to substitute a like reconditioned product with similar characteristics. If not prohibited by local law, a handling fee may apply.
- 3) This warranty will be considered NULL and VOID in the following cases:
  - a) Damage to the product due to mishandling, alteration, accident, impact, sand and/or liquid or moisture damage, tampering, battery or chemical corrosion, failure to follow operating, maintenance, or environmental instructions prescribed by the instruction manual, shipping damage, excessive use; or,
  - b) Damage caused during service performed by anyone other than the authorized PROMASTER service center; or,
  - c) If the product has had its serial number or other identifying data altered or removed; or
  - d) Damage, defect, or unsatisfactory performance caused by the use of accessories not manufactured or distributed by PROMASTER; or,
  - e) The product was not purchased from an Authorized PROMASTER dealer.
- 4) In no event will PROMASTER be liable for any damage, including any loss of film, other inconvenience, lost profits, lost savings, or other incidental or consequential damages arising out of the use or inability to use this product.

For service, return this product to your nearest PROMASTER Dealer (a listing may be found at [www.promaster.com](http://www.promaster.com)) or pack it carefully as to avoid any damage and return it prepaid to:

**PROMASTER WARRANTY CENTER**  
**2950 Turnpike Drive, Section 6 – 9**  
**Hatboro, PA 19040**

Be sure to include a copy of your sales receipt which clearly identifies your product, your name, and the date and place of purchase. In addition be sure to include a brief description of the problem you are experiencing with the product.

**Made in Taiwan**

Part Number of this User Manual

[www.promaster.com](http://www.promaster.com)  
Fairfield, CT 06825